

---

The following page(s) are extracted from multi-page Kuhnke product catalogues or CDRoms and any page number shown is relevant to the original document. The PDF sheets here may have been combined to provide technical information about the specific product(s) you have selected.

Hard copy product catalogues, and CDRoms have been published describing Kuhnke Pneumatics, Solenoids, Relays and Electronics; some divided into different books. A list of current publications is available on this web site or from our sales offices. Some may be available for download, but as substantially larger files.

## Contact Details

Kuhnke sales and service in the UK

H. Kuhnke Ltd  
Unit 6 Focus 303  
Focus Way, Walworth Business Park  
Andover  
Hampshire  
SP10 5NY  
United Kingdom

Tel: +44 (0)1264 364194  
Fax: +44 (0)1264 365991  
Email: [sales@kuhnke.co.uk](mailto:sales@kuhnke.co.uk)

### Important Note

The information shown in these documents is for guidance only. No liability is accepted for any errors or omissions. The designer or user is solely responsible for the safe and proper application of the parts, assemblies or equipment described.

---



## Industrial Switching Relay I

- Standard type , specify in order
- Twin contacts for high contact making reliability
- 2, 4, 6 or 8 C/O possible
- Large contact gap, switching voltage therefore 400 V
- Supplied with blow-out magnet for high DC loads

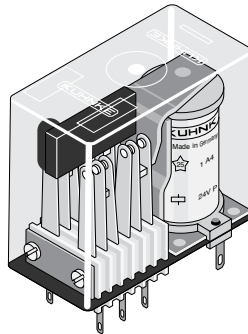

## Order Code

Order code	I	A	4		-	24 V	DC	
Type of relay	I							
Model								
A Plug-in type for socket or soldered connection		A						
C For 2.8 mm connector, B-extension required for EN-mounting		C						
G For printed circuit		G						
Contact arrangement								
2 C/O			2					
4 C/O			4					
6 C/O (for DC only)			6					
8 C/O (for DC only)			8					
Contact material, type of contact								
- Hard silver (no code letter)				-				
C AgCdO				C				
F Twin contacts hard silver				F				
G Twin contacts hard silver gold-plated				G				
Nominal operation coil voltage (see coil data)								
24 V						24 V		
Coil current type								
DC Direct current							DC	
AC Alternating current 50 Hz (60 Hz on request) for IA2 and IA4 only							AC	
Extensions								
- None (no code letter)								-
M Blow-out magnet								M
B Quick-action fastening for rail EN50022-35 x 7.5 (combination M/B not for IA2/C2)								B



## Contact Data

	I			
Contact arrangement	2, 4, 6, 8 C/O			
Type of contact	Single contact		Twin contact	
Contact material	hard silver	AgCdO	hard silver	hard silver gold-plated
Nominal contact current	6 A		4 A	
Inrush current	≤ 20 A		≤ 10 A	
Nominal contact voltage	400 VAC, 250 V (with 8 C/O)			
Max. switching capacity (resistive)	3000 VA, 2000 VA (with 8 C/O)		1200 VA	
Min. switching capacity	50 mA / 20 VDC	50 mA / 20 VDC	20 mA / 10 VDC	1 mA / 100 mV

## Dimensions, Connection Diagram(s)

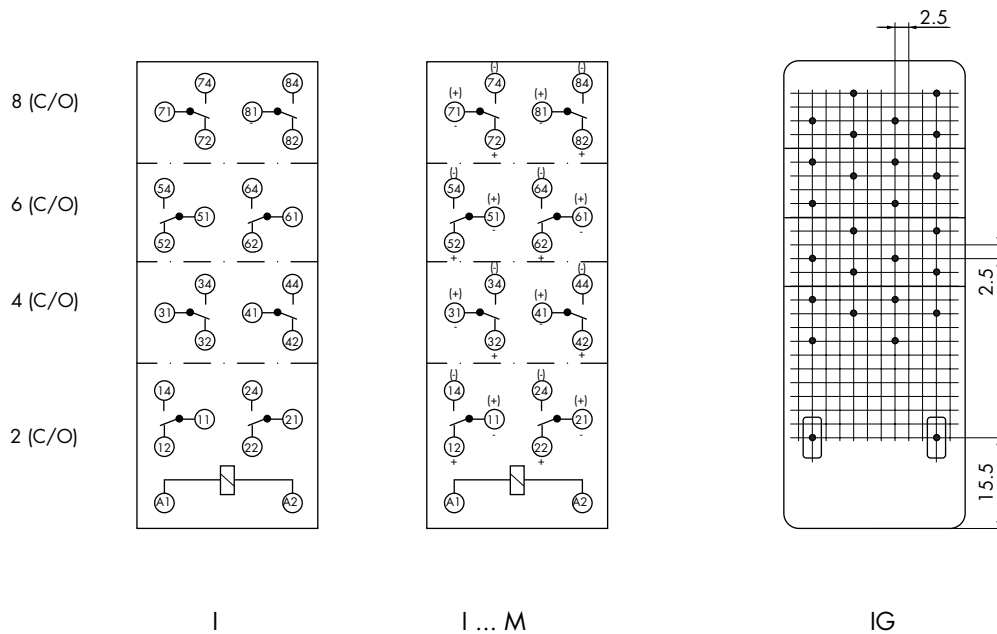
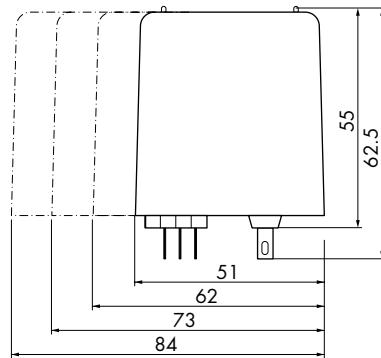
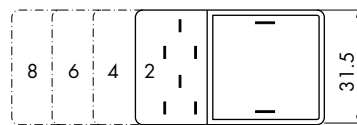



## General Data

	I	
Pull-in-time	approx. 15 ms	
Drop-out time	approx. 10 ms	
Bounce time	approx. 6 ms	
Mechanical service life	> 20 x 10 <sup>6</sup> switching cycles DC > 15 x 10 <sup>6</sup> switching cycles AC	
Test voltage	Coil - contact 2500 VAC (C/O) - (C/O) 2500 VAC Contact - contact 1000 VAC	
Insulation group VDE 0110b/2.79	C250, B380	
Ambient temperature	-25 °C to +60 °C DC -25 °C to +40 °C AC	
Vibration resistance (30 - 100 Hz)	> 2 g	
Weight	approx. 140 g to 180 g	
Operating range	DC Class 1 (0.8 - 1.1 U <sub>N</sub> )	AC, 50 Hz Class 1 (0.8 - 1.1 U <sub>N</sub> )
Pull-in after coil excitation with U <sub>N</sub> at T <sub>U</sub>	20 °C	
Drop-out	> 0.05 U <sub>N</sub>	> 0.15 U <sub>N</sub>

## Coil Data

Coil voltage DC*	IA2 Nom. operation coil power appr. 0.9 W Pull-in power appr. 0.5 W		Coil voltage AC, 50 Hz*	IA2 Nom. operation coil power appr. 3.5 VA Inrush current appr. 1.7 x nominal current	
	Nom. resistance (Ω)	Nominal current (mA)		Nom. resistance (Ω)	Nominal current (mA)
12	208	58	12	7.7	250
24	702	34	24	37	100
40	1980	20	42	106	67
60	4030	15	60	208	50
110	12800	8.6	110	853	22
220	48700	4.5	230	3120	13

\* Other voltages on request

Coil voltage DC*	IA4 Nom. operation coil power appr. 1.7 W Pull-in power appr. 0.8 W		Coil voltage AC, 50 Hz*	IA4 Nom. operation coil power appr. 5 VA Inrush current appr. 1.7 x nominal current	
	Nom. resistance (Ω)	Nominal current (mA)		Nom. resistance (Ω)	Nominal current (mA)
12	88	140	12	5	420
24	363	66	24	22	210
40	853	47	42	71	110
60	1980	30	60	139	80
110	8010	14	110	458	46
220	30500	7.2	230	2350	21

\* Other voltages on request

Coil voltage DC*	IA6 Nom. operation coil power appr. 3.3 W Pull-in power appr. 1.4 W		Coil voltage DC*	IA8 Nom. operation coil power appr. 3.3 W Pull-in power appr. 1.4 W	
	Nom. resistance (Ω)	Nominal current (mA)		Nom. resistance (Ω)	Nominal current (mA)
12	47	260	12	47	260
24	164	150	24	164	150
40	458	87	40	458	87
60	1060	57	60	1060	57
110	4030	27	110	4030	27
220	12800	17	220	12800	17

\* Other voltages on request



## Electrical Service Life

### Electrical Service Life AC

90 % operating

- resistive load
- - - - inductive load
- $\cos \varphi = 0.4 \dots 0.7$

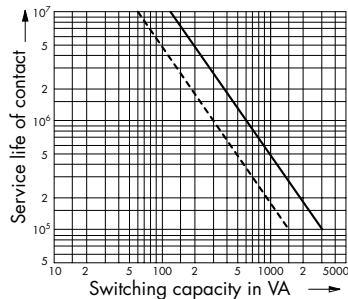

2, 4, 6 C/O

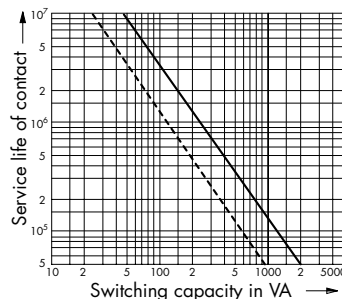

8 C/O

### Switching Capability DC

without blow-out magnet

Below limiting characteristic: service life of contacts

$1 \times 10^6$  switching cycles (90 % operating)

resistive load

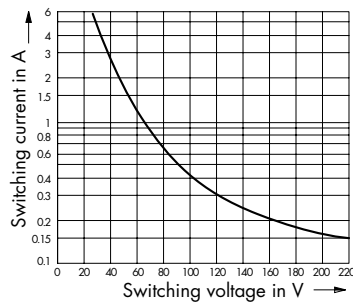

2, 4, 6 C/O

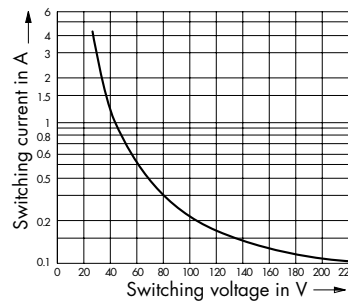

8 C/O

### Electrical Service Life DC

with blow-out magnet, resistive load with 2, 4, 6 and 8 C/O

Switching current (A)	Voltage (V)	Service life switching cycles approx.	Voltage (V)	Service life switching cycles approx.	Voltage (V)	Service life switching cycles approx.
1	24	-	110	$0.7 \times 10^6$	220	$0.2 \times 10^6$
2		$1.5 \times 10^6$		$0.5 \times 10^6$		$2.5 \times 10^6$
4		$0.8 \times 10^6$		$2.0 \times 10^6$		$2.5 \times 10^6$
6		-		$3.0 \times 10^6$		$0.6 \times 10^6$
8*		$2.0 \times 10^6$		-		$0.1 \times 10^6$
10*		$2.0 \times 10^6$		$0.1 \times 10^6$		
12*		$0.3 \times 10^6$				

\* not admitted for continuous current

## Order Specifications for Accessories

Relay	IA2	IA4	IA6	IA8
Socket for screw connection with quick-action fastening	Z382.02			
Retaining clip	Z482			
Mounting bracket	Z582		Z582	
Electrical shock protection for Z382.02, 2 pcs. per socket	Z382.50			



## Industrial Heavy Duty Relay IH

- 1 N/O for 16 A
- Long service life of contact at high switching capacity

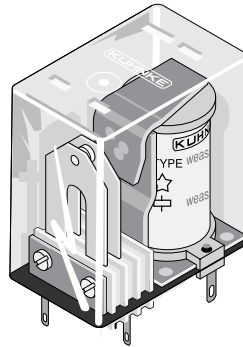

## Order Code

<b>Order code</b>	<b>I</b>	<b>H</b>	<b>100</b>	<b>-</b>	<b>24 V</b>	<b>DC</b>	
Type of relay	I						
Model							
H Plug-in type for socket or soldered connection		H					
Contact arrangement							
100 1 N/O			100				
Nominal operation coil voltage (see coil data)							
24 V					24 V		
Coil current type							
DC Direct current						DC	
AC Alternating current 50 Hz (60 Hz on request)						AC	
Extensions							
- None (no code letter)							-
B Quick-action fastening for rail EN50022-35 x 7.5							B

## Contact Data

	<b>IH 100</b>
Contact arrangement	1 N/O
Type of contact	Single contact
Contact material	Hard silver
Nominal contact current	16 A
Inrush current	≤ 50 A
Nominal contact voltage	400 VAC / DC
Max. switching capacity (resistive)	4000 VA
Min. switching capacity	50 mA / 20 VDC



## Dimensions, Connection Diagram(s)

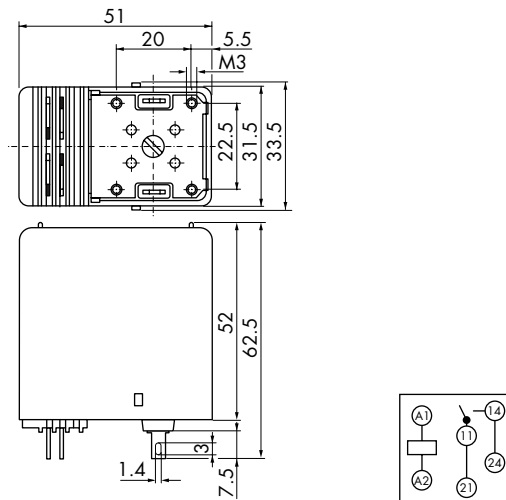

Viewed on terminals

## General Data

	IH 100	
Pull-in-time	approx. 15 ms	
Drop-out time	approx. 10 ms	
Bounce time	approx. 8 ms	
Mechanical service life	> 15 x 10 <sup>6</sup> switching cycles	
Test voltage	2500 VAC	
Coil - contact	2500 VAC	
Insulation group VDE 0110b/2.79	C250, B380	
Ambient temperature	-25 °C to +75 °C DC -25 °C to +40 °C AC	
Vibration resistance (30 - 100 Hz)	> 4 g	
Weight	approx. 140 g	
Operating range	DC Class 1 (0.8 - 1.1 U <sub>N</sub> )	AC, 50 Hz Class 1 (0.8 - 1.1 U <sub>N</sub> )
Pull-in after coil excitation with U <sub>N</sub> at T <sub>U</sub>	20 °C	
Drop-out	> 0.05 U <sub>N</sub>	> 0.15 U <sub>N</sub>

## Coil Data

Coil voltage* DC	IH 100 Nom. operation coil power approx. 0.9 W Pull-in power approx. 0.5 W			Coil voltage* AC, 50 Hz*	IH 100 Nom. operation coil power approx. 5 VA Inrush current approx. 1.7 x nominal current	
	Nominal voltage (V)	Nom. resistance (Ω)	Nominal current (mA)		Nominal voltage (V)	Nom. resistance (Ω)
12	208	58	24	22	210	
24	702	34	230	2350	21	
40	1980	20				

\* Other coil voltages on request



## Electrical Service Life

### Electrical Service Life AC

90 % operating

— resistive load

- - - inductive load

$\cos \varphi = 0.4 \dots 0.7$

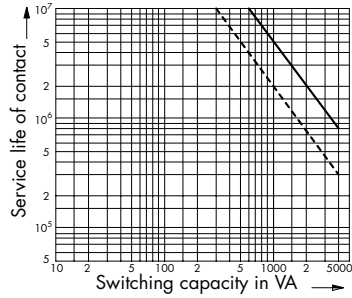

### Switching Capability DC

Below limiting characteristic: service life of contacts

$1 \times 10^6$  switching cycles (90 % operating)

resistive load

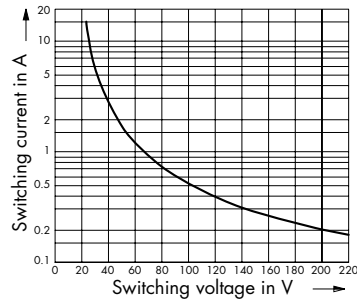

## Order Specifications for Accessories

Relay	IH100
Socket for screw connection with quick-action fastening	Z382.02
Retaining clip	Z482
Mounting bracket	Z582
Electrical shock protection	Z382.50



## Socket Z382.02

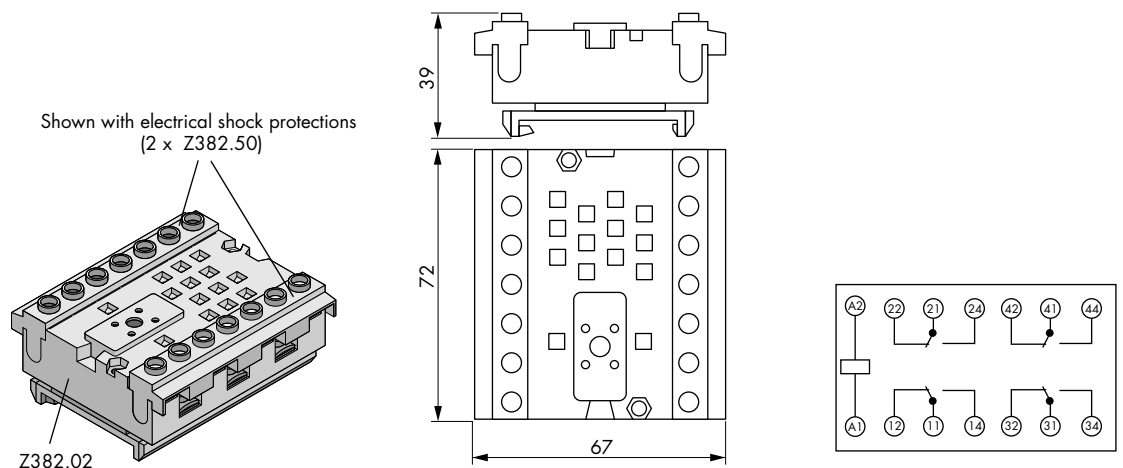

Socket	Z382.02
Socket design	
Terminal capacity solid conductor flexible conductor with ferrule	2 x 2.5 mm <sup>2</sup> 2 x 1.5 mm <sup>2</sup>
Terminal designation	in accordance with EN50005
Mounting	Rail EN50022-35 x 7.5/15
Screw terminals	Head screws metric M4
Torque in accordance with DIN EN 60999	1.2 Nm
Nominal current	6 A
Insulation group VDE 0110b/2.79	C250
Electrical shock protection	Electrical shock protection optional 2 x Z382.50
Weight	105 g
Retaining clip	Z482

## Mounting Bracket Z582

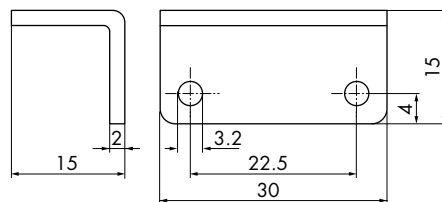

	Z582
Mounting	with screw M3 to relay
Weight	approx. 11 g